

**KEY
NEW
OWNER
WISDOM
YOUR PT6A
TURBOPROP**

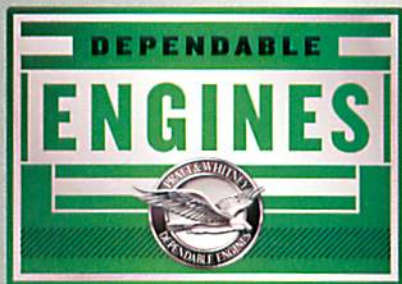

Pratt & Whitney Canada

A United Technologies Company

KNOW YOUR PT6A TURBOPROP

Congratulations on your acquisition of an aircraft powered by the Pratt & Whitney Canada Corp. (P&WC) dependable PT6A Turboprop Engine! Just like you, operators around the globe have made the PT6A engines their choice in the business and general aviation market – engines known to provide exceptional power, performance and peace of mind. By making this wise choice, you are benefiting from 45 years and 300 million hours of in-service experience resulting in unmatched reliability..

This handbook has been designed to give you a brief overview of the PT6A engine as well as some maintenance and power management recommendations. Always refer to the Pilots Operating Handbook (POH), Aircraft Flight Manual (AFM), Engine Maintenance Manual (EMM), Service Bulletin's (SB) or other service information documentation for a complete text of the approved / recommended procedures and latest information.

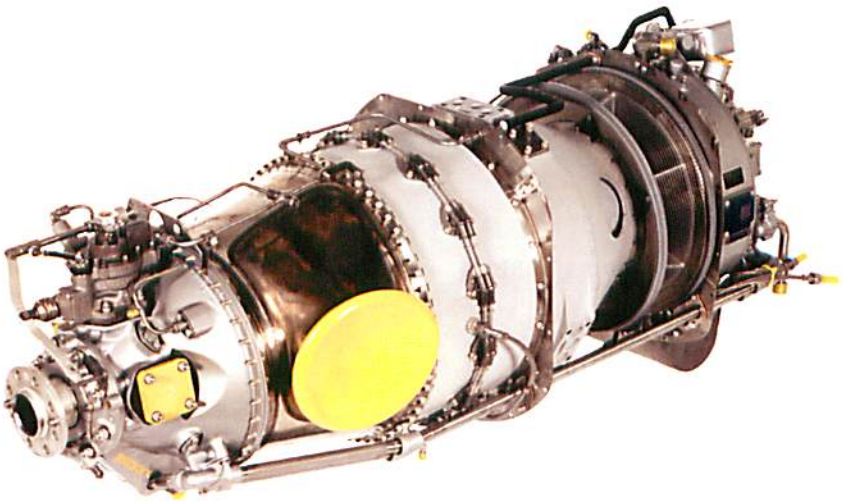

Should you require additional information related to:

AOG / critical emergency services

Technical / maintenance consultation

Warranty

Publications

Field Service Representative (FSR) contact info

Rental Engines

Engine status in any P&WC Service Centre

Eagle Service Plan® (ESP®)

AOG Parts After Hours,

our Customer FIRST Centre is available 24 hours a day,
7 days a week to assist you.

In Canada and the United States:

Tel: 1-800-268-8000

International:

Tel: International Access Code + 8000-268-8000

Other Numbers:

Tel: (450) 647-8000 Fax: (450) 647-2888

Email:

cfirst@pwc.ca

Visit our website at:

www.pwc.ca

KNOW YOUR PT6A TURBOPROP

Take note of your PT6A engine model and serial number.
This will help us to coordinate our support in a timely manner.

Engine Model: _____

Engine Serial Number: _____

Engine Logbook:

Each engine is supplied with a logbook(s) to record all maintenance actions as well as engine running times and cycles. The logbook(s) must accompany the engine or module each time they are sent to an approved service or overhaul facility.



DISCLAIMER

Disclaimer

The information contained herein has been set out in summary form and is provided for general reference purposes only and may be changed without prior notice. It should not be construed as creating any obligation on the part of Pratt & Whitney Canada Corp. While every care has been taken to avoid errors, Pratt & Whitney Canada Corp. makes no representations about the accuracy of these guidelines and accepts no responsibility for any error herein. In no event shall P&WC be liable for any damages whatsoever resulting from the misuse, misinterpretation, analysis, interpretation or application of any of the guidelines contained herein. The information contained herein does not replace or supersede the information contained in the appropriate airframe or engine maintenance manuals or other official publications.

Always refer to the Pilot's Operating Handbooks (POH), Aircraft Flight Manuals (AFM), Engine Maintenance Manuals (EMM), Service Bulletins (SB) or other Service Information documentation for a complete text of the approved / recommended procedures and latest information.

PT6 and PT6A are trademarks of Pratt & Whitney Canada Corp.

© Copyright Pratt & Whitney Canada Corp. May not be reproduced, in whole or in part, without prior written consent

NOMENCLATURE

ADAS	Aircraft Data Acquisition System
AFM	Aircraft Flight Manual
AGB	Accessory Gearbox
AOG	Aircraft On Ground
CT	Compressor Turbine
ECTM[®]	Engine Condition Trend Monitoring [®]
EESP	Extended Engine Service Policy
EPL	Emergency Power Lever
ESP[®]	Eagle Service Plan [®]
FOD	Foreign Object Damage
FSR	Field Service Representative
HSI	Hot Section Inspection
ITT	Interturbine Temperature
LCF	Low Cycle Fatigue
MOR	Manual Override
Ng	Gas Generator Speed

NOMENCLATURE

Np	Propeller Speed
PPSP	Primary Parts Service Policy
PLA	Power Lever Assembly
POH	Pilot's Operating Handbook
PT	Power Turbine
RPM	Rotations Per Minute
SB	Service Bulletin
SHP	Shaft Horsepower
SIL	Service Information Letter
STOL	Short Takeoff and Landing
TBO	Time Between Overhaul
TSO	Time Since Overhaul
TTSN	Total Time Since New
TCSN	Total Cycles Since New
UAC	United Aircraft Corporation
Wf	Fuel Flow Rate

Initial Customer Support Presentation

P&WC offers a three-part introduction to the company, engine maintenance and our aftermarket support logistics. You have the option of scheduling a meeting at your convenience or we will be happy to send you an information kit with brochures and a copy of the presentation that you may review at your leisure. When the time comes, your local FSR can provide guidance on such things as fuel nozzle exchange, boroscope inspection of the hot section or other maintenance areas.

Publications

P&WC offers a package of high-quality technical publications for new aircraft operators. Moreover, a free two-year revision service is provided for each new publications subscription. Additional publications may also be purchased. The price list for commercial publications is available upon request by contacting Publications Customer Services.

For additional details on our Technical Publications, including contact info, please visit us at our website, www.pwc.ca

Warranty

P&WC prides itself in offering transferable warranty coverage that is amongst the best in the aerospace business. The new engine warranty is comprised of the Basic Coverage Period and may be supplemented by one or both of the following available service policies:

- The Primary Parts Service Policy (PPSP) is a renewable pro-rata warranty coverage for the repair or replacement of specific engine parts damaged due to a defect in material or manufacturing workmanship during their P&WC commercially-supported class life.
- The Extended Engine Service Policy (EESP) applies for a premature, engine-chargeable event when an overhaul is required.

KNOW YOUR PT6A TURBOPROP

Once we have been informed of a new PT6A engine delivery to an aircraft operator, a copy of the applicable new engine warranty will be sent to the new owner by the P&WC Warranty Administration department. Notification of new aircraft sales is normally received directly from aircraft manufacturers, their licensed dealers or directly from the owner. Note that warranty coverage is attached to the engine serial number, not to the owner. For any warranty questions, please feel free to email us at warranty@pwc.ca.

If your aircraft is involved in an incident which affects the engine (e.g. prop strike, hard landing), you must inform P&WC Warranty by filling out the form included in SIL GEN-039. This will ensure that your warranty policy is reinstated following the corrective maintenance actions.

Customer Portal

Pratt & Whitney Canada is committed to providing global support services that delights our customers. The P&WC Customer portal is just one of the many ways in which we collaborate with our customers. The portal will give access to an increasing list of on-line services and information.

Register today on our website, www.pwc.ca, free of charge, to receive the P&WC Extranet Application URL, username and password once the registration request has been approved and processed.

PT6A Engine Overview

Unmatched versatility, dependability and performance have made the PT6A engine the most thoroughly proven and popular turboprop engine family in the 500- to 1,700-shp class, covering a diverse range of applications across all aircraft markets. We continually invest in technology to make our engines the most environmentally friendly and to offer even greater value in the form of higher performance and digital engine control.

The PT6 engine, a lightweight free turbine engine incorporating a reverse flow combustion path, is designed for aircraft propulsion use. It utilizes two counter-rotating turbines; one driving the compressor and the other driving the propeller through a reduction gearbox. The latter turbine is “free” or independent of the compressor turbine. More recent, higher powered models incorporate a two-stage power turbine.

Over the years, the PT6 engine has evolved and adapted to a multitude of uses. The PT6A engine is the turboprop designation, powering commuter, corporate and utility aircraft, aerobatic trainers, agricultural aircraft, short takeoff and landing (STOL) aircraft and water bombers. This handbook is dedicated to the PT6A variant.

The PT6B, C & T (Twin-Pac®) engines are turboshaft variants, providing reliable power to many of the worlds helicopters and more recently to tiltrotors.

The ST6 engine is an industrial variant of the PT6 engine, originally developed for the United Aircraft Corporation (UAC) TurboTrain and intended for stationary application.

MODULARITY

The design of the PT6A engine allows it to be split into two major parts called the power section assembly and the gas generator assembly. Only certain engine models are defined as being modular, which allows the interchange and tracking of each module. Three criteria must be met for the engine to be modular.

1. Each major assembly is equipped with a data plate and a third data plate is located on the inlet case for the complete engine assembly.
2. There is a logbook for each module.
3. In the appropriate SB on service lives, there will be an overhaul interval quoted for each module and the engine assembly.

On non-modular PT6A engines, the power section assembly can be removed and sent for service, but must be returned and installed on the same gas generator assembly.

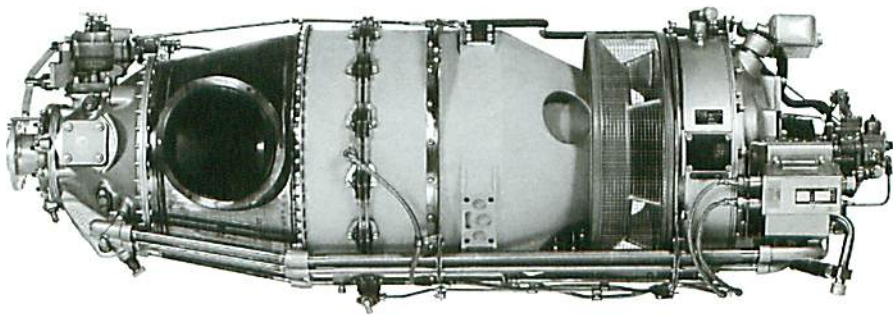

Small PT6A Engine

ADVANTAGES OF THE PT6A ENGINE DESIGN

A number of advantages are derived from the design of the PT6A engine which have proven valuable in routine field operation.

During an engine start, only the compressor section of the PT6A engine needs be rotated by the starter-generator. By comparison, a fixed-shaft engine must spin all rotating components including the reduction gearbox and propeller during an engine start, resulting in a requirement for heavier starting systems.

The PT6A engine free turbine design allows the propeller RPM to be reduced and the propeller feathered during ground operation without shutting down the engine. This facilitates fast passenger loading and permits very quiet ground operation. Propeller RPM can also be varied in flight (on most applications) permitting propeller RPM to be set for quieter cruise and optimum efficiency.

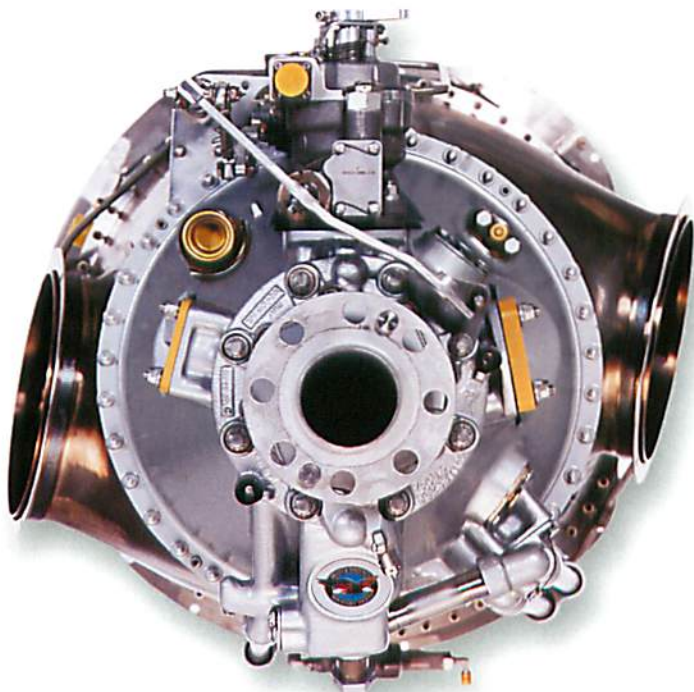

PRINCIPLES OF OPERATION

The PT6A engine consists of two main sections, the gas generator section and the power section.

The gas generator section compresses and delivers air to the combustion chamber where it is mixed with fuel and ignited. The resulting hot gases turn the compressor turbine which provides the power to run the compressor and the accessory gearbox located at the rear of the engine. The hot gases continue on to the power turbine where the remaining energy is extracted to turn the propeller.

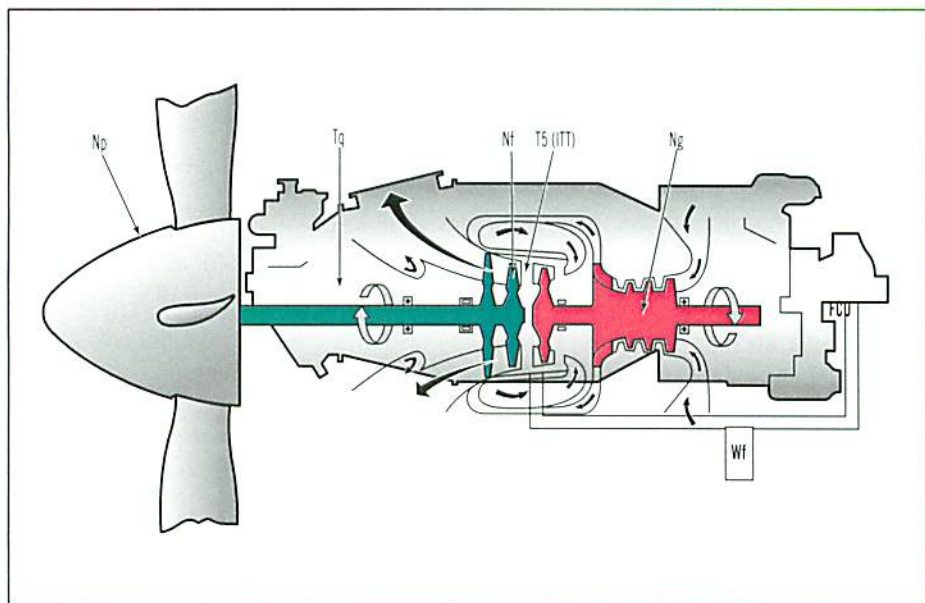

AIRFLOW

Air is directed to a compressor consisting of three axial stages (Four axial stages on large PT6A engine models) and one centrifugal stage. Compressed air leaving the compressor passes through diffuser pipes which turn the flow 90 degrees, reduce its speed and direct the air into the combustion chamber.

In the annular combustion chamber the air is mixed with fuel and burned. Two igniter plugs are used to light the fuel/air mixture when the engine is started. They are not required to maintain the combustion process and can be shut off once the engine has reached idle speed.

The expanding hot gases are directed first through the compressor turbine and then through the power turbine. After passing through the power turbine, the gases are exhausted through ports on each side of the engine. (Some engines are fitted with a single-port exhaust.) The exhaust stubs fitted to the engine are normally directed to utilize the remaining energy of the gases in the form of thrust for additional aircraft propulsion.

Two bleed air systems are incorporated in the PT6A engine. Automatic bleed air from the compressor prevents compressor stall during acceleration from low engine speeds or deceleration from high engine speeds. For aircraft use, air may be bled for heating or pressurizing aircraft cabins.

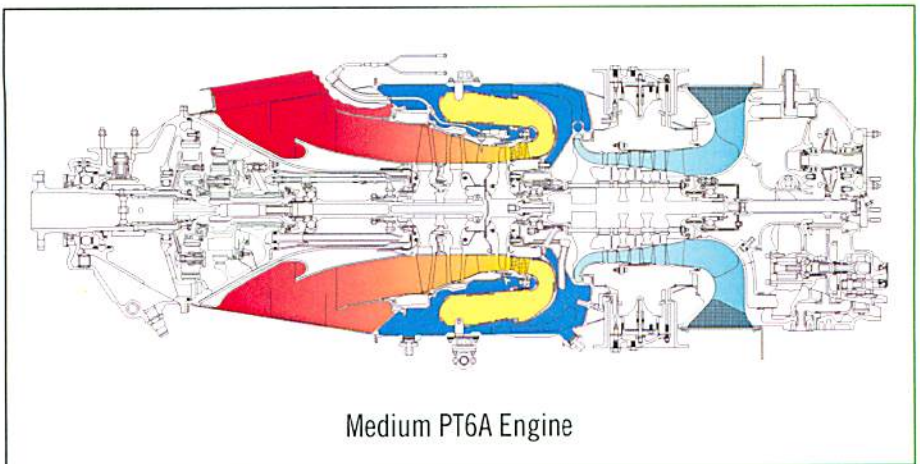

POWER TRAIN

A shaft connects the power turbine to the two-stage planetary reduction gearbox. The first stage reduction ring gear floats axially against a hydraulic torquemeter cylinder. The oil pressure in this cylinder is proportional to output torque which is displayed on the torque indicator in the cockpit. Bevel gears located forward of the second stage planetary gears drive the following accessories mounted on the forward reduction gearbox case:

- propeller governor or constant speed unit
- propeller overspeed governor
- tachometer-generator

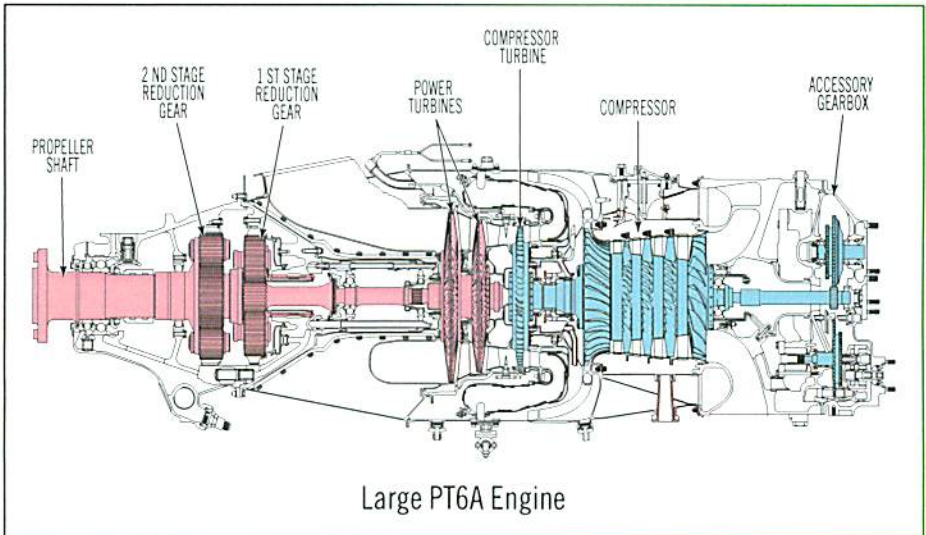

The accessory gearbox, mounted on the rear of the engine, is used to drive the following engine accessories:

- High-pressure fuel pump
- Fuel control unit
- Oil scavenge and oil pressure pumps.

Space is also provided for aircraft manufacturer provided accessories such as the starter-generator, gas generator tachometer-generator, fuel boost pumps or hydraulic pumps.

BEARINGS

Support of the main shafts in the PT6A engine is accomplished by a combination of ball and roller bearings. Ball bearings support axial and radial loading, while the roller bearings support only radial loads, allowing for thermal expansion.

Propeller Shaft	Power Turbine	Compressor
No. 5: Roller	No. 3: Roller	No. 1: Ball
No. 6: Ball	No. 4: Ball	No. 2: Roller
No. 7: Roller**		

** Smaller reduction gearboxes do not utilize a No. 7 bearing.

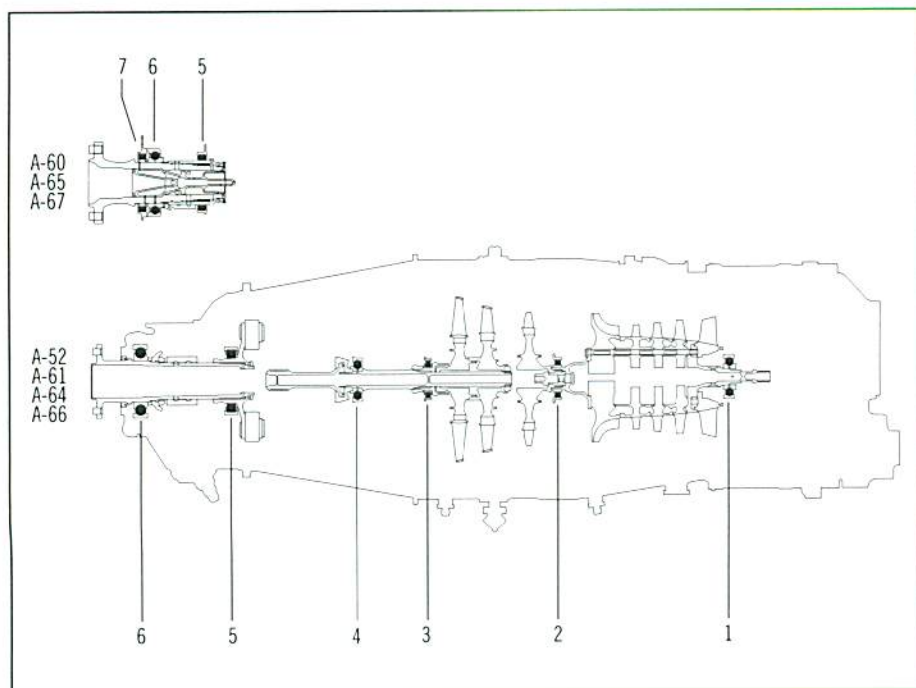

Inertial Separator

The nacelle inlet of many aircraft models includes an inertial separator provided by the aircraft manufacturer to prevent heavy particles from entering the engine inlet. Most installations incorporate two moveable vanes, one upstream of the engine inlet and the other blocking the bypass duct. For bypass operation, the inlet vane is lowered and the bypass duct vane is opened permitting maximum separating efficiency. In some installations, the vanes are fixed in the bypass mode.

As shown in the sketch, air entering the engine inlet must turn sharply past the inlet vane (shown in the lowered position). Particles heavier than air are carried straight through, by their own inertia, into the bypass duct and dumped overboard.

The aft radial inlet design provides many advantages such as superior anti-icing utilizing the principle of inertial separation, low noise levels and unequalled protection from FOD.

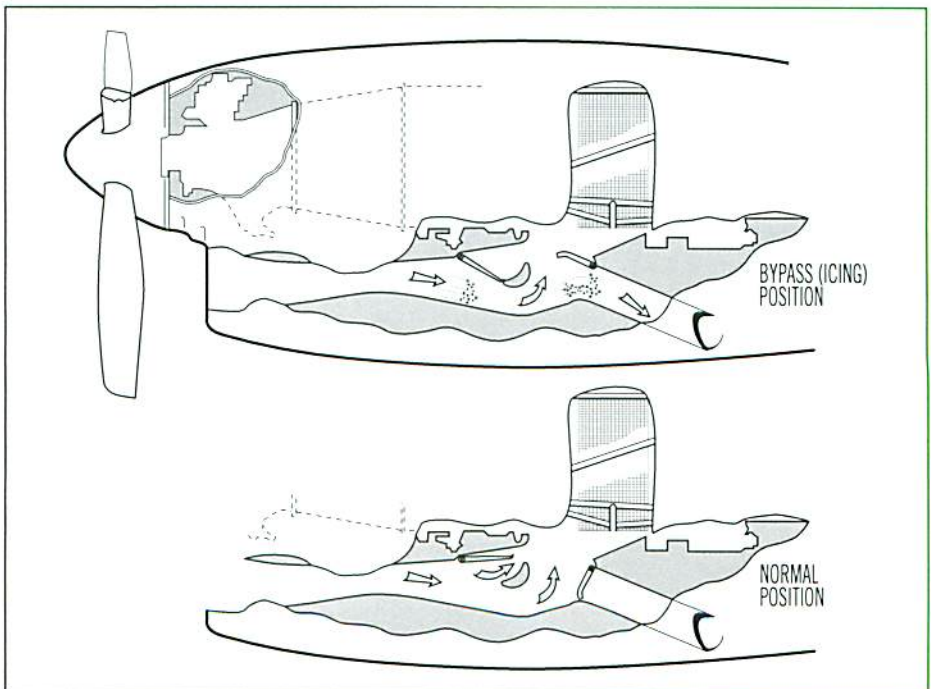

FUEL SYSTEM

The fuel system is designed to deliver clean fuel to the engine at the pressure and flow that are necessary for all engine operating conditions.

The airframe fuel system contains the necessary boost pumps, transfer pumps, selector/shutoff valves, strainers and filters required to supply fuel to the engine(s) and to manage the fuel load distribution in the airplane.

The engine is equipped with a fuel system which consists of a fuel heater, high-pressure fuel pump, fuel filter, fuel control unit, start control or flow divider unit and a manifold with fuel injection nozzles.

The fuel control unit is either a hydro-pneumatic or a hydro-mechanical system which meters the correct amount of fuel to the engine to maintain the gas generator speed selected by the pilot via the power control lever. It also controls fuel flow scheduling during engine starting, acceleration and deceleration.

The PT6A engine is approved for operation with all commercial jet fuels, JP-4, JP-5 and for a maximum of 150 hours during any overhaul period with all grades of aviation gasoline. Specific grades of diesel fuel are approved as alternate fuels for restricted use. No engine adjustments are required in changing from one fuel to another, nor is it necessary to purge the fuel system when changing fuels, except when using alternate fuels.

For listings of approved fuels and fuel additives refer to the appropriate Service Bulletins for each PT6A engine model.

OIL SYSTEM

The PT6A engine has a self-contained oil system with the exception of the oil cooler, air duct and associated plumbing. The oil level should be verified after engine shutdown and while the oil is still hot, using either a dipstick or a sightglass.

For more information related to the oil system, please refer to page 29.

TYPICAL PT6A ENGINE INSTRUMENTATION

Incorporated into the design of the PT6A engine are accurate and reliable torque and ITT measuring systems that give the pilot an accurate indication of the primary engine operating parameters.

Torque Pressure is sensed by a torque pressure transducer mounted on the reduction gearbox, to indicate the torque being developed by the engine. Torque is the primary parameter used to set power for takeoff and cruise operation for specified propeller speeds.

ITT is monitored to ensure that combustion gas temperature limits of the engine are not exceeded.

Two tachometer-generators are installed on the engine: one on the reduction gearbox monitors propeller speed (N_p), and the other on the accessory gearbox monitors gas generator speed, (N_g).

Pressure and temperature gauges monitor the oil system.

CONTROLS

Cockpit Powerplant Controls

PT6A engine applications use the engine power management system and propeller beta control capability to obtain optimum airplane flight and ground handling capability. The powerplant functions are typically commanded from the cockpit by means of three control levers and push-pull cables.

In some applications where certain powerplant functions are not required, simplified systems using two or even one cockpit control lever may be used.

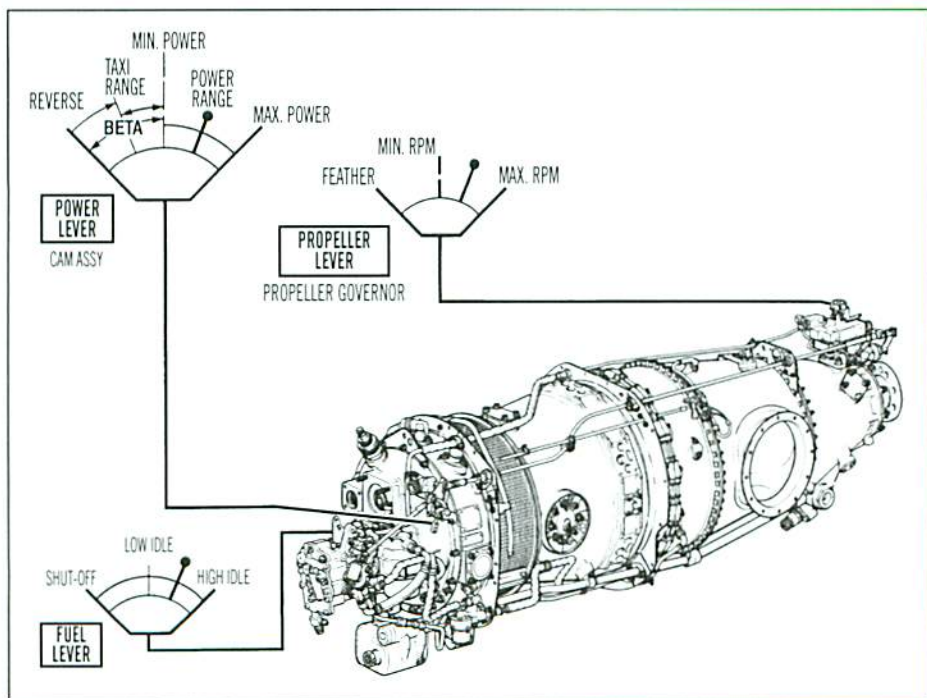

Control	Location	Control Function
Condition	Fuel control unit (or start control)	Fuel cut-off and idle speed(s)
Power	Fuel control unit	Gas Generator speed
Propeller	Propeller governor	Prop speed and feathering

Secondary control inputs located on the propeller governor include the beta valve and the fuel governor reset. These controls are used in conjunction with the propeller low blade angle feedback system and the engine propeller reversing control system for propeller beta control and reverse thrust control. A cambox unit is part of the engine control system and its purpose is to schedule gas generator speed and propeller angle by means of linkages to the fuel control power lever and to the propeller governor beta valve and fuel governor reset controls.

Propeller Low Blade Angle Reset Systems

During the development program of an airplane, the most desirable propeller low pitch limits (primary blade angle) and engine flight idle settings required for optimum flight handling are determined. In some cases, certain ground operating requirements such as propeller restricted speed ranges may dictate a different propeller low pitch limit for ground operation. Some installations utilize an airframe-supplied propeller low pitch reset system actuated by means of a switch which senses the weight of the airplane on the main landing gear. This functionality is integrated with the engine-supplied propeller beta control system. The system automatically sets the propeller low pitch limit to either the ground or light positions.

Automatic Feathering

Takeoff performance for multi-engine aircraft is based upon having one engine inoperative. Most multi-engine aircraft are equipped with aircraft manufacturer provided automatic feathering systems to reduce drag on the aircraft. However these systems are normally not armed during most other phases of flight. Automatic feathering is not used in single-engine PT6A engine applications. Please refer to the applicable AFM for specific operating instructions.

Because the free turbine configuration of the PT6A engine has less rotating inertia than a fixed turbine engine, an unfeathered propeller creates less in-flight drag. Therefore, negative torque sensing systems are not required.

Propeller Overspeed Governor

All PT6A turboprop installations are equipped with an airframe-supplied propeller overspeed governor. This unit has its own dedicated drive from the engine reduction gearbox and is intended to limit the propeller speed to a predetermined maximum value in the event of a malfunction of the primary propeller governor.

In most installations which feature an automatic feathering system, the automatic propeller feathering function is performed by an electrically-activated propeller servo oil dump valve on the overspeed governor.

Overtorque Limiter

On some PT6A engine installations an overtorque limiter is installed to limit maximum engine output torque to a preset value. This function has been utilized on applications where the normal power setting and monitoring procedures cannot be used, such as military trainer aircraft which are intended to maintain the maximum operational similarity to high-performance jet aircraft. Other applications with substantially flat rated PT6A engines utilize an overtorque limiter to prevent inadvertent excessive power settings by the pilot.

An electronic limiter system is also installed on some engine models intended for military trainer aircraft. This system offers both torque and ITT limiting capability.

Manual Override

All PT6A engines intended for single-engine aircraft are equipped with a manual override function installed on the fuel control unit. The manual override can be connected to an Emergency Power Lever (EPL) in the cockpit by an airframe-supplied linkage, if required by the aircraft manufacturer.

Introduction

The manual override function, when connected to the EPL, is intended for use during emergencies or closely monitored training only and must never be used during normal engine operation.

This lever should only be used to modulate engine power to allow the pilot to continue flight to the nearest airport in the event of malfunction in the fuel control pneumatic system resulting in one of the following conditions:

1. Uncommanded power roll back and inability to recover with the Power Lever Assembly (PLA).
2. No response to PLA movement, when starting from or around idle.
3. PLA becomes stuck at or around idle.

The EPL does not duplicate the function of the PLA and is not to be used as an optional means of controlling the engine.

The EPL overrides all automatic fuel control features and acts directly on the fuel valve to directly modulate the fuel flow to the engine. Rapid movements of this lever should not be made for any reason whatsoever. EPL sensitivity increases with altitude and above 5000 ft., extreme care should be exercised.

Please refer to the applicable AFM or POH for correct operation of the EPL.

CAUTION:

WHEN USING THE MANUAL OVERRIDE SYSTEM, THE ENGINE RESPONSE MAY BE MORE RAPID THAN WHEN USING THE POWER LEVER. A RAPID INCREASE IN EMERGENCY POWER LEVER POSITION TOWARDS MAXIMUM IS TO BE AVOIDED, AS THIS CAN CAUSE ENGINE SURGE, ENGINE OVER-TEMPERATURE, Ng OVER-SPEED OR OVER-TORQUE.

Inappropriate use of the EPL will increase maintenance costs and can be a contributory factor to CT blade fractures.

SCHEDULED MAINTENANCE

The following information is intended as an overview of maintenance practices. For a complete description please refer to the Engine Maintenance Manual (EMM).

Chapter 70-00-00 describes standard practices including servicing the engine oil system.

Chapter 71-00-00 contains information on maintenance practices, including adjustment, test and cleaning.

Chapter 72-00-00 outlines inspection criteria for various sections of the engine.

The inspection procedures are considered a normal function of the operating organization and are intended as a guide for minimum inspection and maintenance requirements. The aircraft manufacturer may have additional requirements or suggest different service intervals. See the airframe maintenance manual for details.

ENGINE INSPECTIONS

Chapter 72-00-00, Table 601, of the EMM contains the minimum recommendations for regular inspections of the engine. There are two primary intervals, ROUTINE and MINOR. More precise intervals are used for specific components when required.

- ROUTINE inspections coincide with the daily or preflight airframe inspection.
- MINOR inspections coincide with a typical airframe zone inspection.

The intervals at which these inspections are performed may be altered by the aircraft manufacturer's maintenance program and approved by the operator's local airworthiness authority. Engines operating in sandy or dusty environments or in smog or salt-laden atmospheres should be subjected to additional inspections for corrosion and compressor erosion.

The engine maintenance manual quotes recommended intervals, which the operator can adjust, based upon operating experience. Typical maintenance actions include:

- Engine washing
 - Compressor Desalination Wash
 - Compressor Turbine Desalination Wash
 - Compressor Performance Recovery Wash
- Foreign Object Damage (FOD) inspection of the compressor
 - Inspection of Compressor Inlet Case for corrosion
 - Inspect the fuel system based upon environment and fuel quality
 - In-situ fuel nozzle cleaning
 - Fuel nozzle inspection, cleaning and tip replacement
 - Ignition system
 - Oil system flush
 - Borescope inspection of combustion chamber, compressor turbine vane and blades

Two areas of the PT6A engine have no scheduled maintenance intervals:

- Reduction gearbox
- Propeller control system

Oil Level Sightglass

Some PT6A engine models are equipped with a sightglass to simplify the inspection of the engine oil level. The sightglass has a centre green zone with red on each end. Engine operation is permitted with the oil level at any point in the green zone. The oil level dipstick must be checked when the oil level is in either the red zone or is not visible in the sightglass.

Oil Level Check

Oil level should be checked regularly and replenished as necessary. Although consistency is the most important factor when establishing a schedule for checking the oil level, P&WC recommends this check be done 15 minutes after every shutdown.

Oil Replenishment

P&WC recommends that the engine not be filled over the “MAX COLD” level on the oil level dipstick. This corresponds with the centre of the green band on the oil level sightglass. A high oil level may result in an increase in either the oil consumption rate or the amount of oil mist passing through the engine oil breather. Each engine will seek its own normal operating oil level.

Space is required in the oil tank for expansion as the oil reaches full operating temperature. If the oil level is over the “MAX HOT” level, drain some of the oil. Refer to the EMM for complete instructions.

A listing of approved oils is provided in the appropriate Service Bulletins for each PT6A model. When switching to another approved oil brand or should oil of different brands or viscosities become mixed it is necessary to drain and flush the complete oil system.

Oil Temperature and Colour

High oil temperature will accelerate the accumulation of carbon particles in the oil and the deterioration of oil additives. Oil colour will darken with usage and exposure to light. The rate of colour change is dependent upon the oil manufacturer's formula. A darkening of the oil does not indicate deterioration in the lubricity of the base stock. Additives are replenished with the addition of oil during level servicing.

Chip Detectors

All PT6A engines are fitted with an RGB chip detector, while some models also have a chip detector in the AGB housing. AGB chip detectors are not equipped with a self-closing valve. When the chip detector is removed, the oil in the accessory gearbox will drain from the engine. During normal operation, there will be approximately ½ litre (17 oz.) of residual oil.

Chip detectors should be checked regularly for continuity and any foreign material. If the aircraft is equipped with a cockpit indication of the chip detector, the whole system should also be checked regularly. Refer to the applicable maintenance manuals for inspection intervals.

Oil Filter Debris Analysis

The oil filter must be changed or cleaned at scheduled intervals. At the same time a visual inspection of the oil filter and chip detectors should be done. This is a simple and reliable method of assessing the wear of oil-wetted parts. As an extra step, a solvent may be used to flush trapped particles from the engine oil filter. The solvent is poured through filter paper to collect the debris. This is referred to as a filter "patch" check.

The filter paper is sent to a laboratory for analysis. Laboratory techniques can be used to determine the alloy of the particles which helps determine their source. With successive samples, a wear trend for oil-wetted parts can be established.

PERFORMANCE CHECK

Over the life of the PT6A engine, the performance charts have evolved in name, style and function. Today, a variety of charts can be found. They may be titled Power Assurance Check, Performance Check or Ground Power Check charts. The charts allow operators of PT6A engines to monitor the condition of their engines and the results of maintenance actions.

The chart may be used over a wide range of ambient temperature and altitude.

The chart is intended to indicate when maintenance action might be required and the results of the repair when data is recorded before and after the maintenance action. With regular use, the chart can become a useful tool for scheduling maintenance.

Check charts do not appear in all engine maintenance manuals. Some of them are published in the airframe maintenance manual.

The performance check is influenced by the powerplant as a whole, not just the engine. The effects of poor nacelle seals, bleed air leaks, accessory drive power and instrumentation errors are all reflected in the recorded data.

Do not use the chart to reject engines from service. Engines may remain in service provided that no operating limits are exceeded at the certified powers. P&WC recommends that troubleshooting and a flight test be done at the typical flight altitude to determine engine serviceability and that any step changes in parameters be investigated.

The performance check charts are based upon estimated “average” engine performance. Every engine has its own unique characteristics. On certain types of performance check charts, this will affect the slope of the lines. By recording data at a few different ambient temperatures, within a short time of each other, the slope for a particular engine can be determined. P&WC recommends that this be done soon after aircraft delivery to establish a baseline for investigating future, performance-related issues.

Atmospheric pollutants may contaminate the engine gas path, leading to a build up of deposits on airfoils, the initiation of corrosion, sulphidation or performance deterioration. These effects can be alleviated with engine washing. Internal engine washes are done while motoring the engine at 10-25% Ng speed for a thorough cleaning.

Compressor Desalination Wash

Used to remove salt deposits which can cause corrosion, however light dirt deposits may also be removed. Wash fluid is drinking quality water, provided minimum standards are met. Water is injected into the engine intake using either an installed compressor wash ring or a hand held wash wand.

Compressor Turbine Desalination Wash

Used to remove salt deposits from the compressor turbine blades and stator which can cause sulphidation, a reaction between the salt and sulphur from the fuel. This wash must be done immediately following a compressor desalination or performance recovery wash as contaminants will be transferred from the compressor to the hot section during a compressor desalination or performance recovery wash. Wash fluid is drinking quality water, provided minimum standards are met. Water is injected through a wash tube inserted through one of the ignitor ports.

Compressor Performance Recovery Wash

Used to remove more stubborn deposits which cannot be removed during normal desalination washes. Wash fluid includes an approved detergent. This wash should only be done when engine performance loss is noticeable or trend monitoring dictates. Wash fluid is injected into the engine intake using either an installed compressor wash ring or a hand held wash wand. A water rinse of both the compressor and compressor turbine is required following the detergent wash.

ENGINE WASHING

External Engine Wash

Used as an effective method of tracing oil leaks, as well as removing salt and other environmental contaminants from the engine external surfaces. Wash fluid is drinking quality water, provided minimum standards are met.

Wash Schedule

When operating continuously in a salt laden environment (typically within 10 nautical miles from the sea and under 10,000 ft), it is recommended to perform compressor and compressor turbine desalination washes and external washes daily, after the last flight of the day to prevent corrosion from initiating overnight. For occasionally salt laden operation, weekly desalination washes and external washes are recommended. Performance recovery washes are only recommended when a noticeable performance shift is recorded. In all cases, engine washing frequency should be based on operator experience and regular inspections of engine components to check for initiation of corrosion.

Refer to P&WC SIL PT6A-144 for additional information and FAA Advisory Circular 43-4A for a comprehensive overview of corrosion. On the next page you will find a map of North America showing areas where environmental conditions will require particular attention to corrosion. Maps of the rest of the world can be found in the above mentioned Advisory Circular.

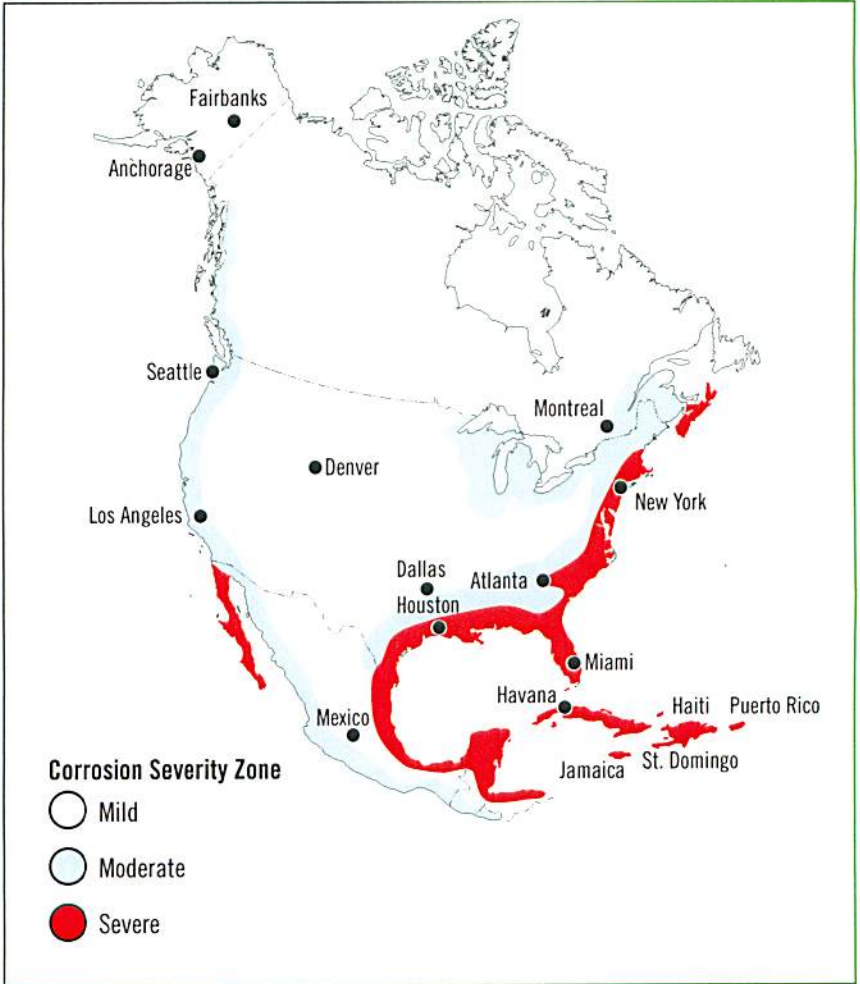

Figure 1

North American Corrosion Severity Map,
extracted from FAA Advisory Circular 43-4A,

HOT SECTION INSPECTION

A Hot Section Inspection (HSI) is usually done halfway through the basic TBO interval or when performance loss dictates. This involves splitting the engine between the compressor and power turbines at "C" Flange. Since it is generally not necessary to remove the engine from the aircraft during an HSI, the inspection procedure is both simple and fast.



OVERHAUL

The basic Time Between Overhaul (TBO) and Hot Section Inspection (HSI) interval is published in the appropriate Service Bulletin for each PT6A engine model. Under extreme conditions, maintenance action prior to the recommended overhaul life may be necessary.

The TBO interval depends on the specified operation of the engine. The interval can be escalated incrementally with the approval of your airworthiness authority, using an "on-condition" or a sampling program. The current TBO escalation is limited at 8,000 hours for single-engine aircraft and 10,000 hr to 12,500 hr, for twin-engine aircraft, depending on the application.

TBO escalation recommendations take into account the average effect of flight duration, time at a given power level, climate, environment, maintenance practices, utilization and engine hardware standard.

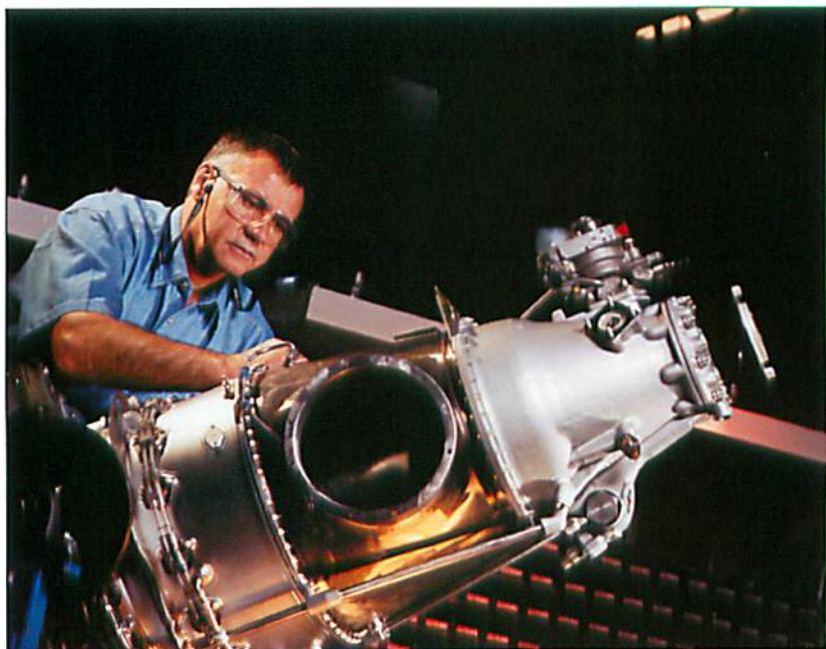

CYCLE COUNTING

Certain rotating components of the engine have a limited life based upon the number of operating cycles they experience. These lives are quoted in the Rotating Component Lives Service Bulletin for each PT6A engine model. It is important to continuously record the number of operating cycles and partial cycles to track rotor lives. Rotor components not supported by proper documentation are to be removed from service. Prior to engine servicing, the total cycles and all flights and starts must be recorded in the appropriate engine logbook.

At engine overhaul, a calculation will be made of the remaining service life for each rotating component. This calculation is based upon the rate of cycle accumulation recorded in the engine logbook.

ECTM® is a computer software program sold by P&WC that assists in early detection of potential problems through continuous monitoring of engine operation. The advantage of using ECTM® is a savings in troubleshooting time, reduced maintenance costs, the ability to schedule corrective action and an increased dispatch rate.

The pilot or an on-board monitoring system must record the readings of the aircraft and engine gauges after the aircraft has been flying at a stable cruise condition for several minutes. Gauge readings are to be recorded daily or once per flight. Alternatively, you may send your recorded trend data to a designated analysis centre for processing and recommendations.

Accurate and consistent readings are crucial to effective trend monitoring; the quality of the engine condition evaluation is only as good as the quality of the data provided.

On-board data recording

Altair Avionics markets a PT6A engine-mounted data recording system called TrendCheck Plus+, and the Aircraft Data Acquisition System (ADAS), an airframe-mounted engine monitor, for a wide variety of PT6A engine applications. These monitors enhance safety and reduce direct operating costs through sophisticated aircraft exceedance monitoring and automated trend sample collection. Operated in conjunction with Altair's internet-based TurbineTracker™ system, these monitors are a powerful diagnostic tool and engine health monitor.

While both systems monitor the engine parameters of turbine temperature, gas generator speed, power turbine speed, torque pressure and fuel flow as well as pressure altitude, aircraft airspeed and ambient temperature each system has their own unique recording capabilities as well. TrendCheck Plus+ system records time history into a storage buffer. The ADAS system provides the ability to monitor the airframe parameters of approach flaps, landing flaps, gear extended and weight on wheels.



Automatic trends can be defined or pilot-initiated samples can be captured by the push of a button. Data stored in the Altair Internet based TurbineTracker™ system can be used directly with the ECTM® program. Additional information on these products can be found at www.altair.aero.

RECOMMENDED PT6A ENGINE POWER MANAGEMENT

The PT6A engine power management system has been designed to give the pilot control of the powerplant thrust over the entire airplane flight and ground-operating envelope. It is a simple and reliable system, which fully compliments the inherent operating flexibility of a free turbine engine.

Mission

In conjunction with the Aircraft Manufacturer, a mission profile is established for every PT6A engine application. This mission is used to analyze and establish engine component lives and durability factors such as Low Cycle Fatigue (LCF), Creep, Oxidation and Vibration. Using this data and taking into consideration airframe influences such as bleed extraction, accessory loading and inlet efficiency, the power setting information is established and then published in the POH / AFM.

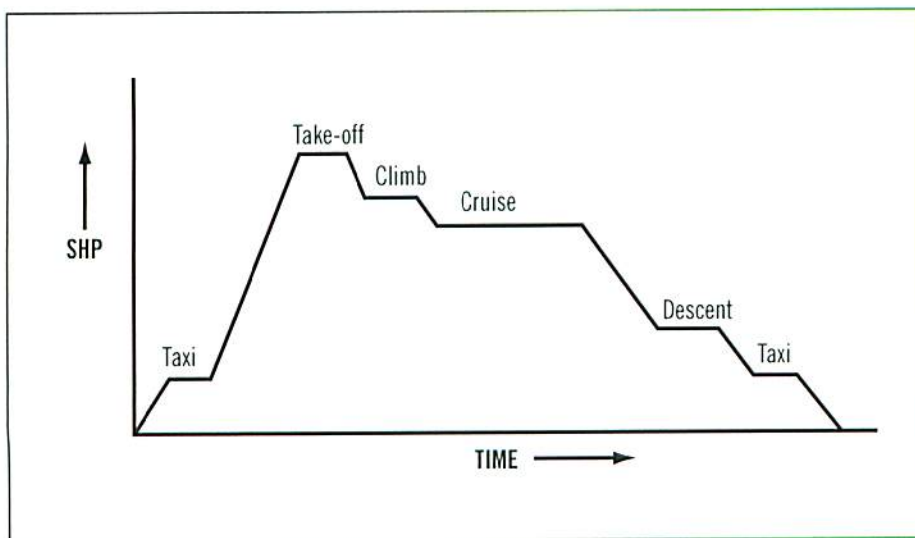

Rating Philosophy

P&WC's power rating philosophy is to ensure the maximum likelihood that your PT6A engine will deliver the power specified in the POH / AFM throughout its overhaul life. To achieve this, all PT6A engine installations use torque as the primary power setting parameter. All other engine parameters are only monitored to verify they are within acceptable limits. The POH / AFM contains power setting information which must be used to determine the torque setting for all ratings which vary according to altitude, ambient temperature and aircraft weight. This is important because the P&WC rating philosophy is based on the engine being operated per the POH / AFM and maintained in accordance with the EMM / AMM including all applicable periodic inspection recommendations by P&WC.

Operating the engine in accordance with the POH / AFM will achieve optimum reliability and durability while minimizing operating costs.

RECOMMENDED PT6A ENGINE POWER MANAGEMENT

Performance Margins

“New Engine” production acceptance limits are designed to allow a sufficient margin to carry the engine through a desired overhaul period. Any engine overhauled and put back into service must meet similar standards.

However, with use, the engine performance margins will gradually reduce characterized by an increase in ITT, N_g and/or fuel flow (W_f) while maintaining POH / AFM specified power

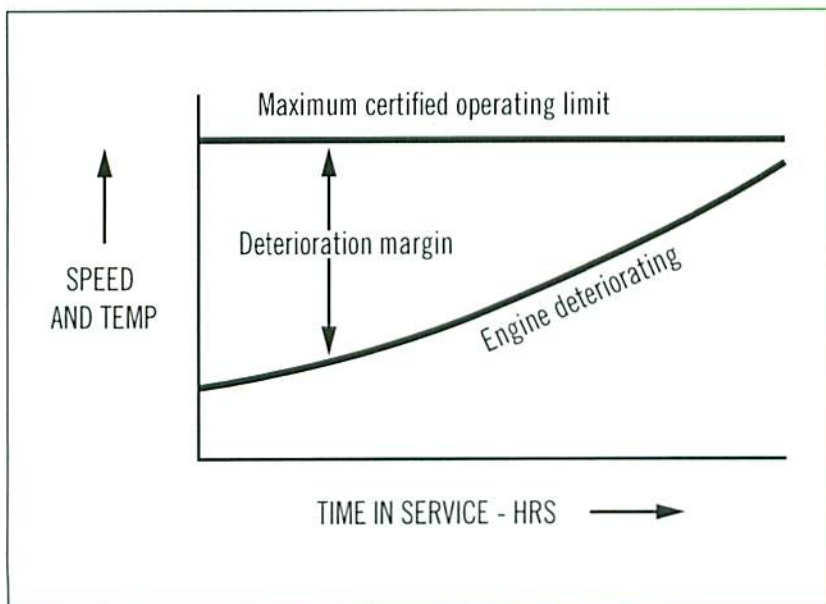

RECOMMENDED PT6A ENGINE POWER MANAGEMENT

Power Ratings

The take-off rating is the maximum power certified for takeoff and is time limited to five minutes.

The maximum continuous rating is a certified power setting for in-flight emergency use only, typically for twin engine applications where one engine is inoperative.

Maximum climb and maximum cruise ratings are the maximum powers approved by P&WC for climb and cruise operation.

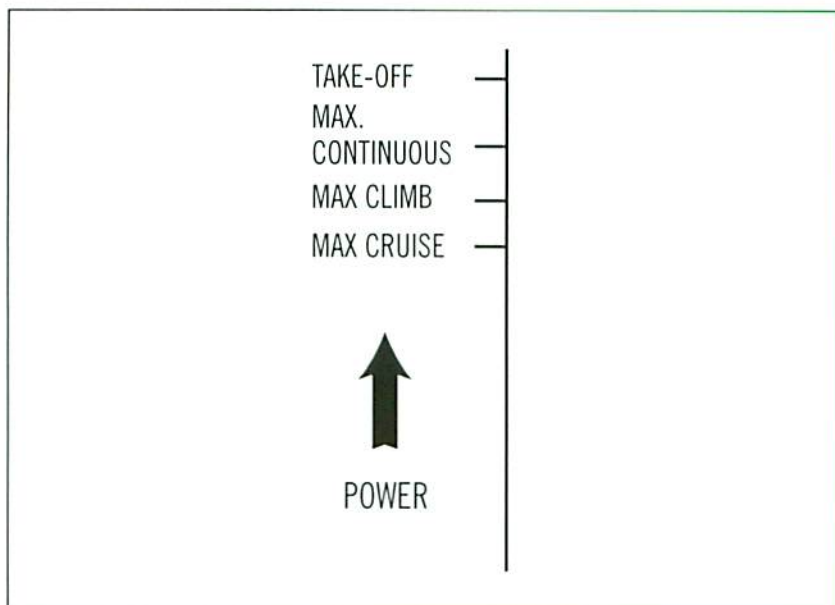

RECOMMENDED PT6A ENGINE POWER MANAGEMENT

Flat Rating

At constant ITT, PT6A engine power reduces with both increasing ambient temperature and altitude. This represents the thermal capacity of the engine or “thermal rating” and is how the engine would perform without the mechanical limitations of the reduction gearbox.

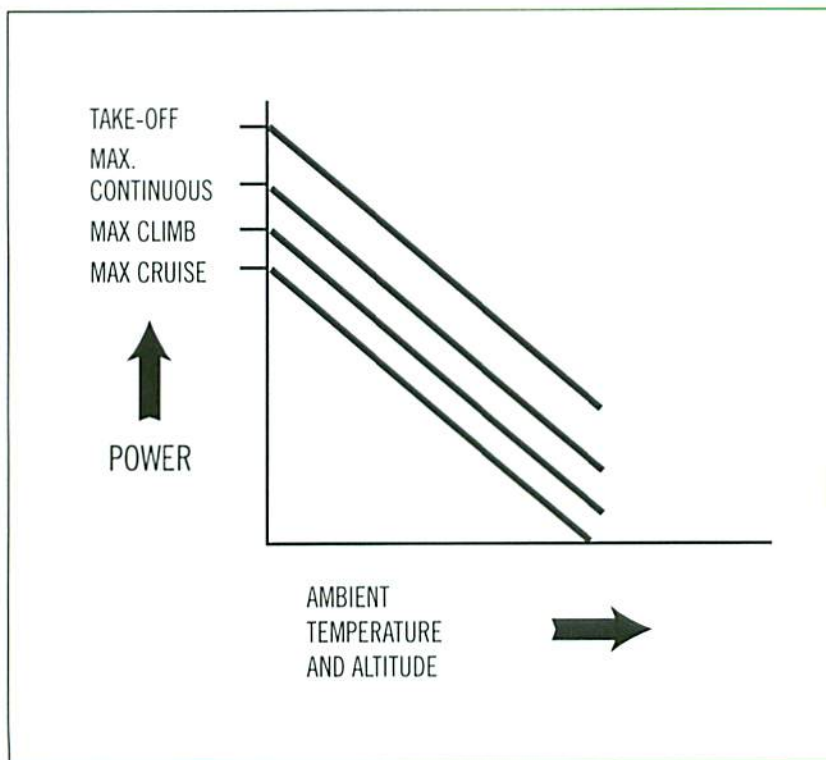

RECOMMENDED PT6A ENGINE POWER MANAGEMENT

It is a general characteristic of aircraft that for a particular gross weight, the power required for take-off varies comparatively little with ambient conditions. PT6A engines are typically “flat rated” to allow for the maximum possible take-off power required by the aircraft over a wide range of ambient temperatures without having to work the engine harder than is necessary at any time.

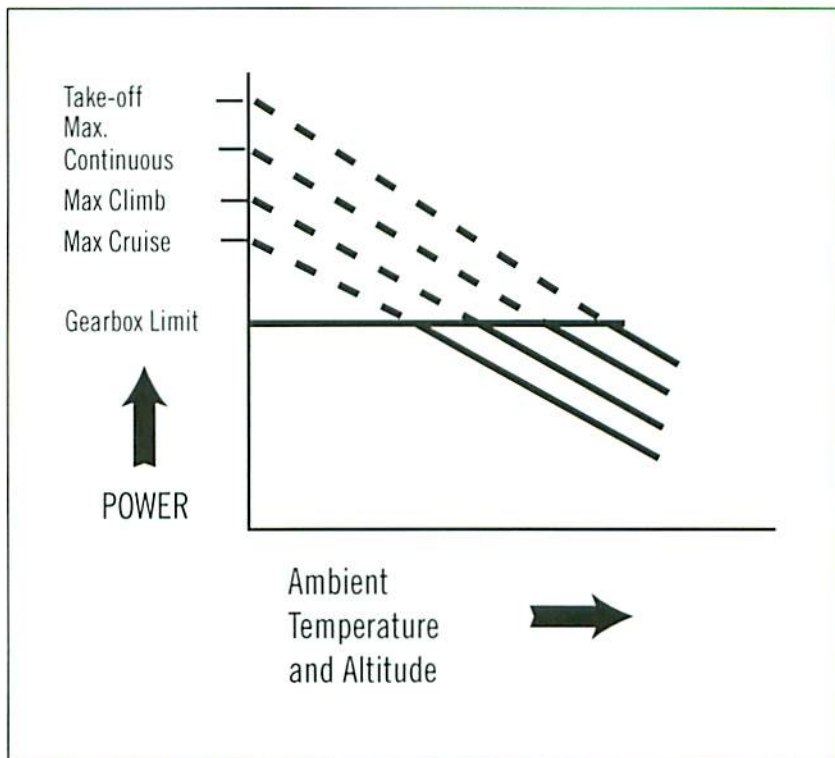

The flat-rated power is available up to the thermal capability of the engine, specified as an ambient temperature and altitude.

RECOMMENDED PT6A ENGINE POWER MANAGEMENT

Power Settings

All PT6A engine applications use engine output torque as the primary power setting parameter. The POH / AFM contains power setting information which must be used to determine the correct torque settings to achieve take off and cruise in accordance with altitude, ambient temperature and aircraft weight.



RECOMMENDED PT6A ENGINE POWER MANAGEMENT

The power lever should be set to the position which produces the required torque. Other engine parameters such as ITT and Ng are monitored only to verify that they are within acceptable limits. Operating the engine in accordance with the POH / AFM by using torque as the primary power setting parameter will achieve optimum reliability and durability while minimizing operating costs.

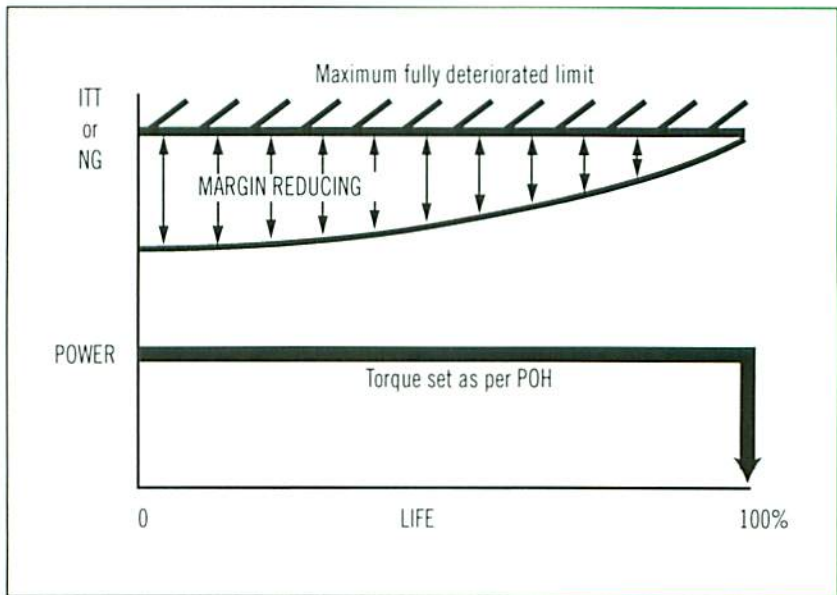

RECOMMENDED PT6A ENGINE POWER MANAGEMENT

Operating the engine beyond the recommended power settings specified in the POH / AFM for a prolonged period will result in accelerated margin deterioration due to hot section component distress and will affect engine reliability and durability. This effect is cumulative and will lead to the engine prematurely reaching an operating limit (usually ITT) before the recommended power is produced.

Refer to P&WC SIL PT6A-125 for additional information.

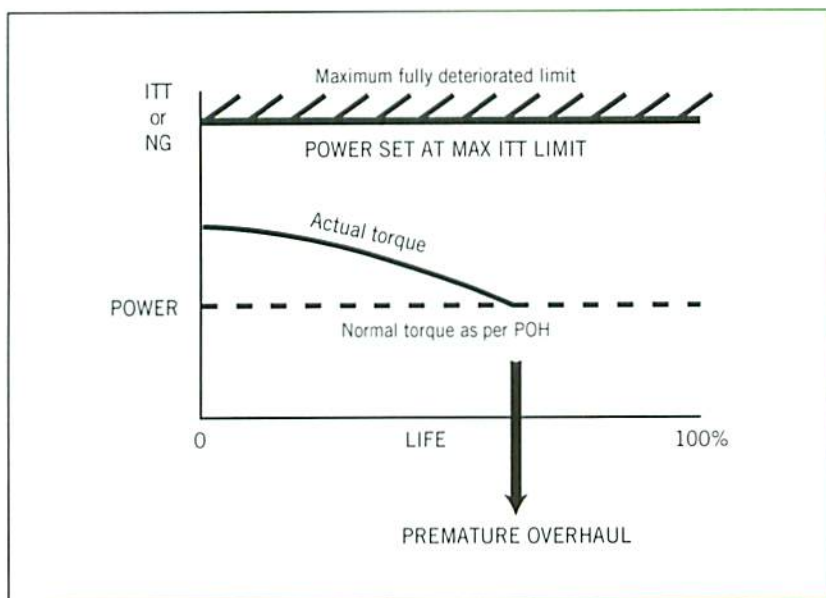

P&WC Customer FIRST Centre

Global Customer Service,
24 –hours a day, 7 days a week

In Canada and the United States:

Tel: 1-800-268-8000

International:

Tel: International Access Code + 8000-268-8000

Other Numbers:

Tel: (450) 647-8000 Fax: (450) 647-2888

Email:

cfirst@pwc.ca

Visit our website at:

www.pwc.ca

